



# TEC3000 Series Single- or Two-Stage Economizer Thermostat Controllers

## Installation Instructions

TEC3330-00-000, TEC3331-00-000,  
TEC3630-00-000, TEC3631-00-000

Part No. 24-10789-5, Rev. D  
Issued November 2016

Refer to the [QuickLIT website](#) for the most up-to-date version of this document.

## Applications

The TEC3000 Series Single- or Two-Stage Economizer Thermostat Controllers are stand-alone and field-selectable BACnet® Master-Slave/Token-Passing (MS/TP) or N2 networked devices provide control of the following:

- unitary rooftop units (RTUs)
- unitary RTUs with economizers
- unitary RTUs with heat pumps
- unitary RTUs with economizers and heat pumps

The networked models feature a field-selectable Building Automation System (BAS) BACnet MS/TP or N2 communication capability that enables remote monitoring and programming for efficient space temperature control. All models include a USB port configuration that reduces installation time by allowing simple backup and restore features from a USB drive, which enables rapid cloning of configuration between like units.

Some models have occupancy sensing capability built into the device. These thermostat controllers maximize up to 30% energy savings in high-energy usage commercial buildings, such as schools and hotels, during occupied times by using additional standby setpoints.

All models feature an intuitive onboard touchscreen UI with backlit display that makes setup and operation quick and easy. Only the single-speed fan configuration is supported for fan coil equipment types.

**IMPORTANT:** The TEC3000 Series Thermostat Controller is intended to provide an input to equipment under normal operating conditions. Where failure or malfunction of the thermostat controller could lead to personal injury or property damage to the controlled equipment or other property, additional precautions must be designed into the control system. Incorporate and maintain other devices, such as supervisory or alarm systems or safety or limit controls, intended to warn of or protect against failure or malfunction of the thermostat controller.

**IMPORTANT:** Le TEC3000 Series Thermostat Controller est destiné à transmettre des données entrantes à un équipement dans des conditions normales de fonctionnement. Lorsqu'une défaillance ou un dysfonctionnement du thermostat controller risque de provoquer des blessures ou d'endommager l'équipement contrôlé ou un autre équipement, la conception du système de contrôle doit intégrer des dispositifs de protection supplémentaires. Veiller dans ce cas à intégrer de façon permanente d'autres dispositifs, tels que des systèmes de supervision ou d'alarme, ou des dispositifs de sécurité ou de limitation, ayant une fonction d'avertissement ou de protection en cas de défaillance ou de dysfonctionnement du thermostat controller.

## North American Emissions Compliance

### United States

This equipment has been tested and found to comply with the limits for a Class B digital device, pursuant to Part 15 of the FCC Rules. These limits are designed to provide reasonable protection against harmful interference in a residential installation. This equipment generates, uses and can radiate radio frequency energy and, if not installed and used in accordance with the instructions, may cause harmful interference to radio communications. However, there is no guarantee that interference will not occur in a particular installation. If this equipment does cause harmful interference to radio or television reception, which can be determined by turning the equipment off and on, the user is encouraged to try to correct the interference by one or more of the following measures:

- Reorient or relocate the receiving antenna.
- Increase the separation between the equipment and receiver.
- Connect the equipment into an outlet on a circuit different from that to which the receiver is connected.
- Consult the dealer or an experienced radio/TV technician for help.

### Canada

This Class (B) digital apparatus meets all the requirements of the Canadian Interference-Causing Equipment Regulations.

Cet appareil numérique de la Classe (B) respecte toutes les exigences du Règlement sur le matériel brouilleur du Canada.

## Installation

### Parts Included

- one TEC3000 Series Thermostat Controller with integral mounting base
- one installation instructions sheet

### Location Considerations

Locate the TEC3000 Series Thermostat Controller:

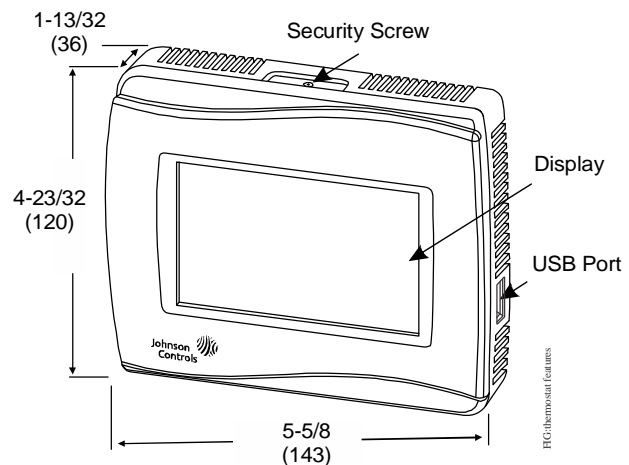
- on a partitioning wall, approximately 5 ft (1.5 m) above the floor in a location of average temperature, allowing for vertical air circulation to the TEC
- away from direct sunlight, radiant heat, outside walls, outside doors, air discharge grills, stairwells, and from behind doors
- away from steam or water pipes, warm air stacks, unconditioned areas (not heated or cooled), or sources of electrical interference

For integrated passive infrared (PIR) models, be sure that the thermostat controller is located centrally, where occupant movement is frequent.

Use insulating foam pads for installations where the wall temperature is different from the room temperature.

**Note:** Allow for sufficient clearance to insert a USB drive into the USB port.

**Figure 1: Thermostat Controller Shown without Occupancy Sensor, Dimensions, in. (mm)**



**IMPORTANT:** Only connect memory devices to the USB port. Do not use it for charging external devices.

## Installing the Thermostat Controller

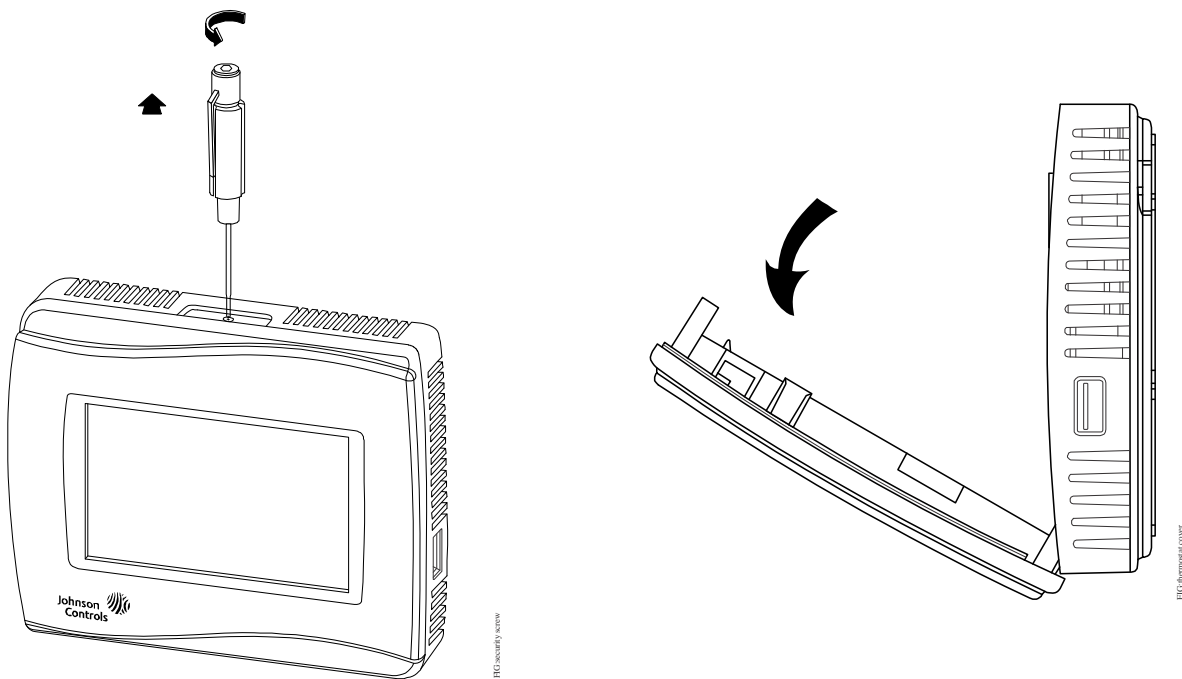
1. Use a 1/16 in. (1.5 mm) Allen wrench or Johnson Controls® T-4000-119 Allen-Head Adjustment Tool (order separately) to remove the security screw if it is installed on the top of the thermostat controller cover. See Figure 2.
2. Pull the top edge of the cover and open the thermostat controller as illustrated in Figure 2.

**IMPORTANT:** The cover is not secured on the bottom. Be careful not to drop the cover.

**IMPORTANT:** If you are installing more than one thermostat controller, keep track of which cover attaches to which base.

**IMPORTANT:** Use proper electrostatic discharge (ESD) precautions during installation and servicing to avoid damage to the electronic circuits of the thermostat controller.

**Figure 2: Removing the Security Screw from the Thermostat Controller Cover (Shown without Occupancy Sensor) (Left) and Removing the Thermostat Controller Cover (Right)**



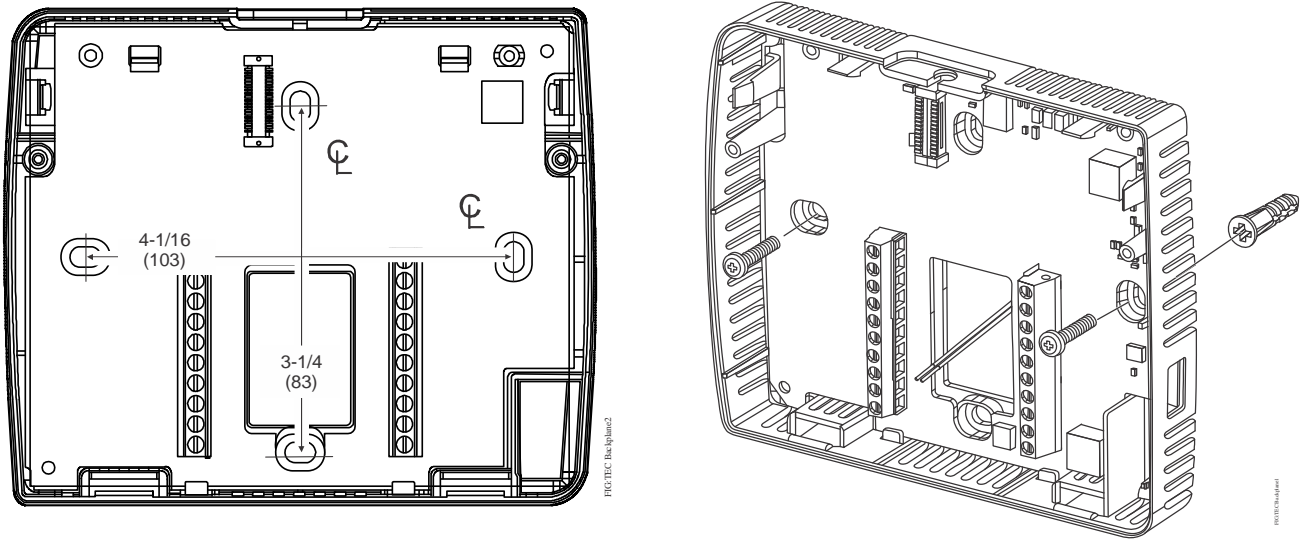
3. Align the thermostat controller mounting base on the wall with the security screw on the top and use the base as a template to mark the two mounting hole locations. See Figure 3.

### Notes:

- If you need to install the thermostat controller on an electrical junction box, use 2-1/2 x 4 in. (63 x 101 mm) square boxes with mud ring covers and avoid smaller 1-1/2 x 4 in. (38 x 101 mm) square or 3 x 2 in. (76 x 51 mm) boxes. This procedure ensures that you have enough space for cabling, if needed.
  - For surface-mounted applications, use durable mounting hardware, such as wall anchors, that cannot be easily pulled out of the mounting surface.
4. Pull approximately 6 in. (152 mm) of wire from the wall and insert the wire through the center hole in the thermostat controller mounting base. See Figure 3.
  5. Secure the mounting base to the wall surface using two mounting screws (user supplied) as illustrated in Figure 3.

**Note:** Be careful not to overtighten the mounting screws.

**Figure 3: Mounting Hole Locations, Dimensions, in. (mm) (Left) and Securing the Thermostat Controller Mounting Base to the Wall (Right)**



## Wiring

When an existing thermostat controller is replaced, remove and label the wires to identify the terminal functions.

### **CAUTION**

#### **Risk of Electric Shock.**

Disconnect the power supply before making electrical connections to avoid electric shock.

### **ATTENTION**

#### **Risque de décharge électrique.**

Débrancher l'alimentation avant de réaliser tout raccordement électrique afin d'éviter tout risque de décharge électrique.

### **NOTICE**

#### **Risk of Property Damage.**

Do not apply power to the system before checking all wiring connections. Short circuited or improperly connected wires may result in permanent damage to the equipment.

### **NOTICE**

#### **Risque de dégâts matériels.**

Ne pas mettre le système sous tension avant d'avoir vérifié tous les raccords de câblage. Des fils formant un court-circuit ou connectés de façon incorrecte risquent d'endommager irrémédiablement l'équipement.

**IMPORTANT:** Make all wiring connections in accordance with local, national, and regional regulations. Do not exceed the electrical ratings of the TEC3000 Series Thermostat Controller.

**IMPORTANT:** Use proper electrostatic discharge (ESD) precautions during installation and servicing to avoid damage to the electronic circuits of the thermostat controller.

To wire the thermostat controller:

1. Strip the ends of each wire 1/4 in. (6 mm) and connect them to the appropriate screw terminals as indicated in Table 2 and Figure 7.

**Note:** For more details on wiring the MS/TP Communications Bus, refer to the *MS/TP Communications Bus Technical Bulletin (LIT-12011034)*.

2. Carefully push any excess wire back into the wall.

**Note:** Seal the hole in the wall with fireproof material to prevent drafts from affecting the ambient temperature readings.

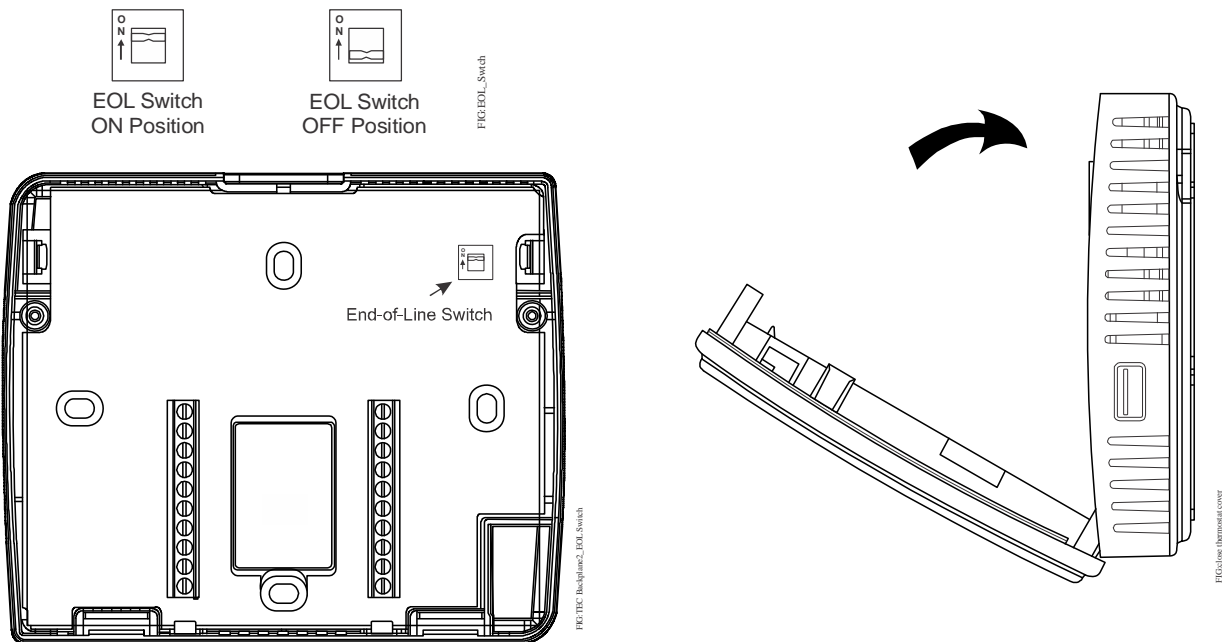
3. Reattach the communication wires to the terminal block.

**Note:** If multiple wires are inserted into the terminals, be sure to properly twist the wires together before inserting them into the terminal connectors.

4. Set the bus end-of-line (EOL) termination switch to the desired location on the TEC3630-00-000 and TEC3631-00-000 models only.

The bus EOL termination switch allows you to designate the thermostat controller as the end of the Field Controller (FC) Bus and N2 Bus. The default position is OFF. If the thermostat controller is at the end of a daisy chain of devices on the FC Bus and N2 Bus, set the EOL switch to the ON position. See Figure 4.

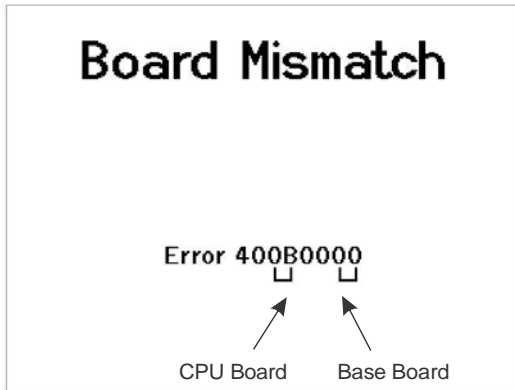
**Figure 4: EOL Switch Positions (Left) and Installing the Thermostat Controller Cover (Right)**



5. Reattach the thermostat controller cover to the mounting base (bottom side first).

**IMPORTANT:** Make sure you reattach the cover that corresponds to its correct base. The CPU board number needs to match the Base board number. Otherwise, an operation error occurs after you reattach a cover and base that do not belong together (as shown in Figure 5). See Table 1 for TEC3000 model names and code numbers.

**Figure 5: Error Code Indicating Mismatched Boards**



**Table 1: TEC3000 Model Names and Code Numbers**

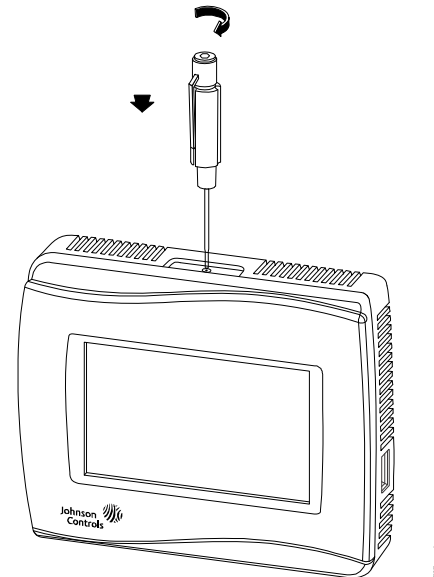
Name	Code Number <sup>1</sup>	Name	Code Number <sup>1</sup>
TEC3310	00	TEC3610	0A
TEC3311	01	TEC3611	0B
TEC3312	02	TEC3612	0C
TEC3313	03	TEC3613	0D
TEC3320	04	TEC3620	0E
TEC3321	05	TEC3621	0F
TEC3322	06	TEC3622	10
TEC3323	07	TEC3623	11
TEC3330	08	TEC3630	12
TEC3331	09	TEC3631	13

1. The two-character code number is listed within the error code to indicate that the CPU board and base board do not belong together. However, if the same code number appears as both the CPU board and base board, there is no error. For example, if 0B is listed as the CPU board and the base board, the model is the TEC3611.

6. Use a 1/16 in. (1.5 mm) Allen wrench or Johnson Controls T-4000-119 Allen-Head Adjustment Tool (order separately) to reinstall the security screw on the top of the thermostat controller cover.
7. Remove the protective plastic cover sheet from the display.

**IMPORTANT:** If the display is dirty, **gently** wipe it clean with isopropyl alcohol or ethyl alcohol. Do not scrub hard as to avoid damaging the surface. Do not use other cleaners such as water, ketone, and aromatic solvents, since they may damage the polarizer.

**Figure 6: Installing the Security Screw from the Thermostat Controller Cover (Shown without Occupancy Sensor)**



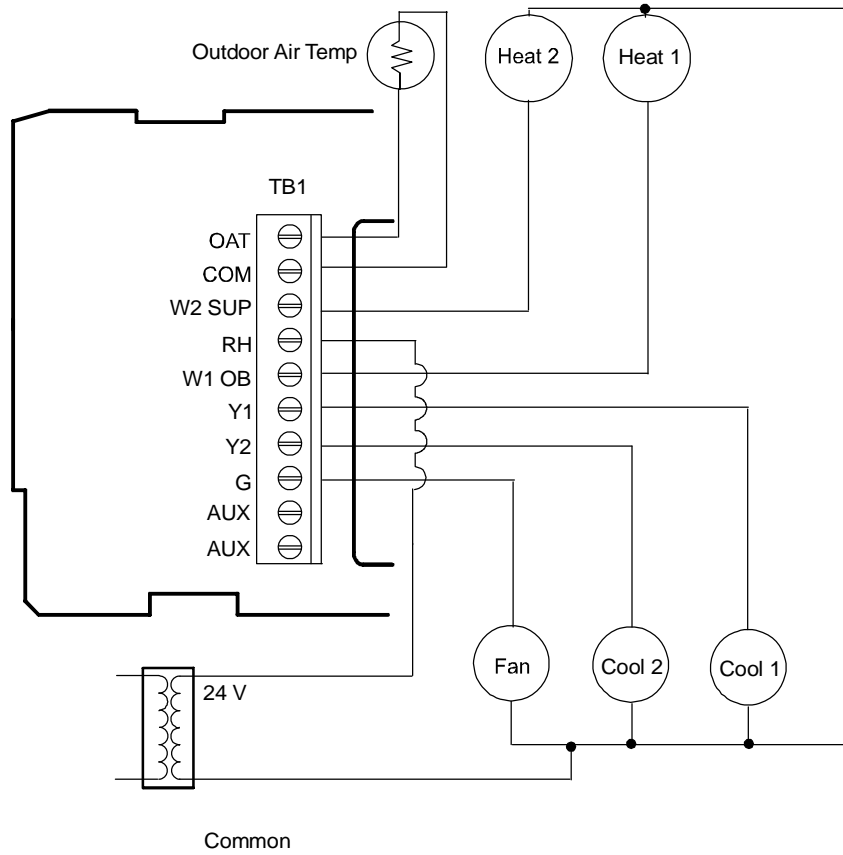
**Table 2: Terminal Identification (See Figure 7 for Wiring Diagram)**

Terminal Label	Function	
	TEC3330, TEC3331	TEC3630, TEC3631
<b>24 V</b>	24 VAC hot from the sensor	
<b>Y1</b>	Cooling stage 1	
<b>Y2</b>	Cooling stage 2	
<b>OAD</b>	Economizer	
<b>AUX</b>	Auxiliary binary output	
<b>AUX</b>	Auxiliary	
<b>W1 OB</b>	Heating 1 (RTU mode)/Reversing valve (O/B) (Heat Pump mode)	
<b>RH<sup>1</sup></b>	Power for W1 and W2	
<b>W2 SUP</b>	Heating 2 (RTU mode)/Supplemental heat (Heat Pump mode)	
<b>OAT</b>	Outside air temperature	
<b>COM<sup>2</sup></b>	Common	
<b>G</b>	Fan	
<b>BI2</b>	Configurable binary input 2	
<b>BI1</b>	Configurable binary input 1	
<b>SAT</b>	Supply temperature sensor	
<b>R SEN</b>	Zone temperature sensor	
<b>NET+</b>	Not connected	Field bus+/N2+
<b>NET-</b>	Not connected	Field bus-/N2-
<b>NET COM</b>	Not connected	Isolated common for field bus

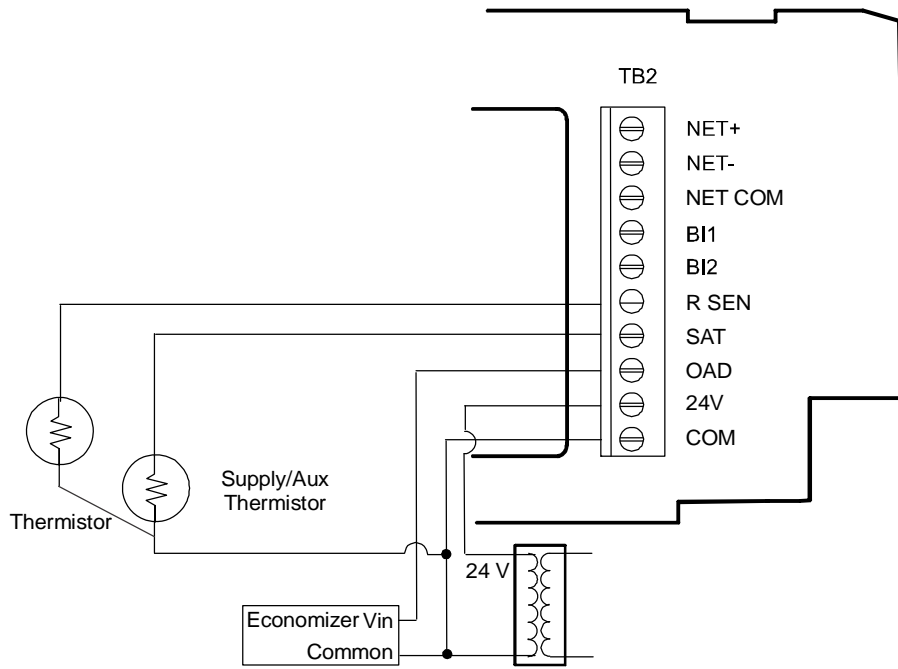
1. RH needs to be connected for W1 and W2 to energize. For heating systems with an isolated power supply, connect RH to the R terminal of the heating system. For systems that switch the hot supply to the heating commands, jumper to 24 V. For systems that switch the neutral supply to the heating commands, jumper to COM.
2. The common terminals (do not include NET COM) are internally connected and can be used for all inputs and outputs.

**Note:** Only one transformer is required for each TEC.

**Figure 7: Staged Wiring Diagram - Rooftop Unit (See Table 2 for Terminal Identification)**



FIGModel 3 Wiring\_input

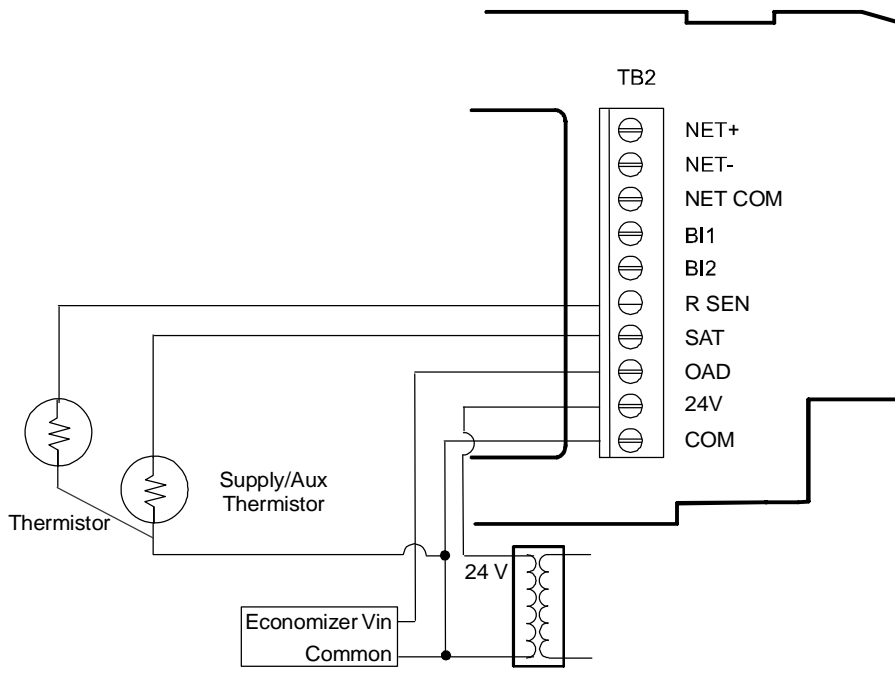
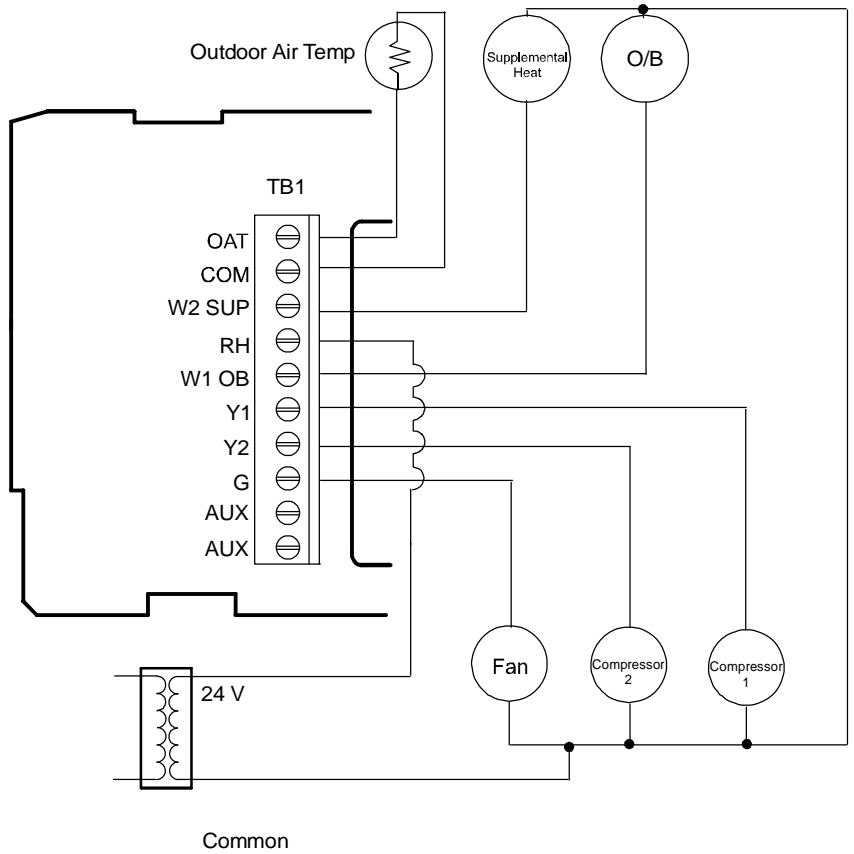


FIGModel 3 Wiring\_output

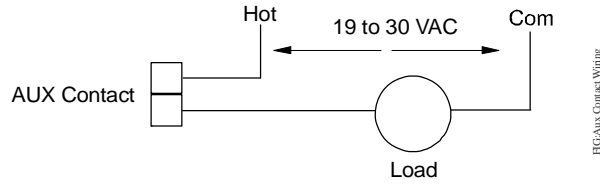


**Note:** Only one transformer is required for each TEC.

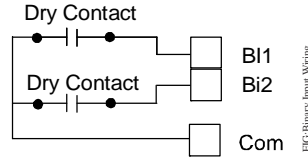
**Figure 8: Staged Wiring Diagram - Heat Pump (See Table 2 for Terminal Identification)**



**Figure 9: AUX Contact Wiring**



**Figure 10: Binary Input Wiring**



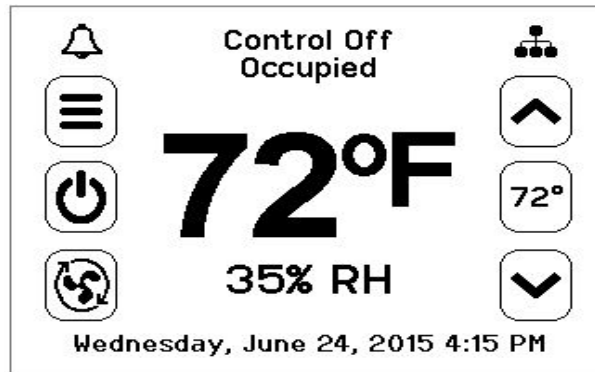
## Setup and Adjustments

**IMPORTANT:** Table 7 provides a full list of TEC3000 menu settings. In the upcoming sections, step-by-step instructions are included on how to access and adjust the more commonly used menus.

### Overview

Figure 11 shows the thermostat controller home screen. You can customize it to show or hide various elements from the occupant. See Table 3 for a listing of the touchscreen icons and Table 7 to identify the home screen settings under the Display Settings. When screen customization is used in conjunction with a passcode, the building owner can control which options the occupant can access and adjust.

**Figure 11: Thermostat Controller Home Screen**



The humidity level appears on the home screen if there is a humidity sensor in the unit, or if the thermostat controller has a network override written to it.

## Customizing the Home Screen

Customizing the Home screen settings include:

- Brightness
- Enable Backlight
- Units
- Time
- Time Zone
- Time Format
- Date
- Date Format

You can also show or hide these items on the home screen:

- Fan Button
- Space Temperature
- Humidity
- Off Button
- Hold Button
- Setpoint
- Alarm Indication
- Occupancy Status
- Unit Status
- Date/Time









To customize the Home screen:

1. Press the Menu icon.
2. Press **Display Settings**.
3. Enable or disable elements of the home screen as appropriate for the building owner and occupants.
4. Set the passcode on the thermostat controller to prevent the occupants from changing settings that they should not have access to change.















## UI Icons

Table 3 describes the home screen touchable icons. Press and release a UI icon activate the TEC. Additional touchable icons appear based on the menu, and those icons are also described in Table 3.

**Table 3: Touchscreen Icons (Part 1 of 2)**

Icon	Icon Name	Description
	Menu	Displays the configuration screens where various settings may be adjusted.
	Alarm	Indicates that the thermostat controller has triggered an alarm.
 	Unit Power On  Off	Powers the thermostat controller on or off. <b>Note:</b> This icon disables all equipment control, but does not physically power down the unit.
	Network Communication	Indicates that the thermostat controller detected a supervisory controller and both are online.
 	Arrow	Increases or decreases a value depending on the configuration screen.
	Run/Hold	Displays the current setpoint. Hold mode is enabled by pressing the button.

**Table 3: Touchscreen Icons (Part 2 of 2)**

Icon	Icon Name	Description
	Hold/Hold	Displays the active setpoint. Hold mode is enabled. No Hold mode is enabled by pressing the button.
	Right Arrow	Proceeds to the next screen.
   	Fan Override On Auto Quiet	Adjusts the fan override between On, Auto, and Quiet.
	Home	Returns the display to the main home screen.
	Back	Returns to the previous screen.
	Save	Saves the current configuration and parameter settings.
	Delete	Deletes the scheduled event.
	Clear	Clears the password entry on the keypad screen.
	Wrench	Indicates that the value is editable.
	Checkmark	Indicates that an event or schedule is programmed for a specific day of the week.
	Exclamation Point	Indicates that an error has occurred.

**Using the USB Port**

The USB port allows you to quickly and easily load firmware upgrades, backup settings, and restore settings to the TEC3000 by using a USB drive. The TEC3000 can recognize eight configuration files or firmware package files. The USB drive format must be FAT or FAT32. The drive cannot be NTFS or USB 3.0. You must have access to the TEC3000 passcode, if a password has been set up, if you are upgrading firmware or copying configuration files. Do not remove the USB drive until the firmware upgrade is complete. The TEC3000 may restart and go offline to the NAE after a firmware upgrade. The upgrade takes approximately three minutes.

Configurations are copied, except for the Communication mode. See [Choosing the Communication Mode \(TEC3630-00-000 and TEC3631-00-000 Models\)](#) to configure each device.

### Loading the Firmware

1. Ensure that the TEC screen is on.
2. Insert the USB drive into the right side of the TEC.  
See Figure 1 for the USB port location.
3. Press the Menu icon.
4. Scroll down the menu and press **Update**.
5. Press **Load Firmware**.
6. Select the correct firmware version. The correct file name has the .pkg extension.
7. Press **Confirm** if you have the correct firmware version.

The firmware is loaded from the USB drive into the TEC3000 operating system. The TEC3000 locates the new firmware only if the new firmware is on the root drive of the USB drive. See [Troubleshooting](#) if the firmware is not loaded correctly.

8. Remove the USB drive from the TEC3000 controller when the update is complete.

The TEC3000 firmware update is complete when the TEC3000 restarts and returns to the home screen.

### Backing Up the Settings

1. Ensure that the TEC screen is on.
2. Insert the USB drive into the right side of the TEC.  
See Figure 1 for the USB port location.
3. Press the Menu icon.
4. Scroll down the menu and press **Update**.
5. Press **Backup**.

A message appears stating that the file is saved locally and on a USB drive.

6. Press **Confirm** if you have the correct firmware version.

The setting files are named based on the TEC3000 model name, date, and time stamp (for example, TEC3311-00\_2015-10-08T1). The files are saved locally and on the USB drive's root directory. See [Troubleshooting](#) if the settings are not backed up correctly.

7. After the settings are saved onto the USB drive, remove the USB drive from the TEC3000.

### Restoring the Settings

1. Ensure that the TEC screen is on.
2. Insert the USB drive into the right side of the TEC.  
See Figure 1 for the USB port location.
3. Press the Menu icon.
4. Press **Update**.
5. Press **Restore**.
6. Select Local Storage or the correct configuration file created from a previous backup operation.






The setting files are named based on the TEC3000 model name, date, and time stamp (for example, TEC3311-00\_2015-10-08T1). The files are saved locally and on the USB drive's root directory.

7. Press **Confirm** if you have the correct file name.

The settings are loaded from the USB drive.

8. After the settings are loaded from the USB drive, remove the USB drive from the TEC3000.

### Choosing the Communication Mode (*TEC3630-00-000 and TEC3631-00-000 Models*)

1. Ensure that the TEC screen is on.
2. Press the Menu icon.
3. Press **Network Setup**.
4. Press **FC Comm Mode**.
5. Select BACnet or N2 by pressing .  
.
6. Proceed to Step 7 to perform BACnet communication and Step 15 to perform N2 communication.
7. Press  to return to the previous screen.
8. Press **BACnet Instance ID**.
9. Enter the BACnet instance ID through the keypad.
10. Press **Save**.
11. Press  to return to the previous screen.
12. Press **BACnet Address**.
13. Enter the BACnet address through the keypad.
14. Press **Save**.
15. After selecting N2 in Step 5, press **Save**.
16. Press  to return to the previous screen.
17. Press **N2 Address**.
18. Enter the N2 address through the keypad.
19. Press **Save**.

### Configuring the Thermostat Controller

Use the Menu icon on the home screen to access and change the basic operating parameters of the thermostat controller. During normal operation, press the Menu icon once to access the following parameters:

- Faults Status
- Display Settings
- Equipment Setup
- Controller Information
- Setpoints
- Control Setup
- System Status
- Commissioning
- Schedule
- Network Setup
- Control Status
- Update

### Installer Configuration Menu

The thermostat controller comes from the factory with default settings for all configuration parameters. The UI menu navigation and default settings are shown in Table 7. Before any outputs turn on, the controller must be configured for the equipment connected to itself. You need to start from the home screen to perform any of the following tasks.



### Screen Reset

The current screen returns to the home screen if the current screen is not touched for 3 minutes.



### **Selecting Rooftop or Heat Pump Mode**

By default, the thermostat controller is configured for Rooftop mode. This mode is used for up to two discrete stages of heating (W1, W2) and up to two discrete stages of cooling (Y1, Y2). Certain heat pumps do not require an O/B input and instead take standard W and Y commands as heat or cool commands, internally sequencing the equipment. For these type of heat pump units, leave the controller in Rooftop mode.

When in heat pump mode, the TEC controls up to two stages of compressors (Y1, Y2) for both heating and cooling. O/B is controlled through the W1/OB output and one stage of supplemental heat is controlled through the W2/SUP output. To configure heat pump mode:



1. Press the Menu icon.
2. Press **Equipment Setup**.
3. Press **Heat Pump**.
4. Press **Heat Pump Supported** and select Yes.
5. If supplemental heating is installed, press **Supp Heating Installed** and select Yes.
6. Press **Reversing Valve Polarity** and set appropriately for the O/B input on the equipment based on if the equipment is normally cooling until the thermostat output is activated or normally heating (typically, Normally Heat for O and Normally Cool for B).
7. Press  to save and  to return to the previous screen.

### **Configuring Heating and Cooling Stages**

1. Press the Menu icon.
2. Press **Equipment Setup**.
3. Press **General**.
4. Press **Number of Compressors** and adjust the number of compressor inputs on the equipment being controlled.
5. If the thermostat controller is in rooftop mode, press **Number of Heating Stages** and adjust the number of heating inputs on the equipment being controlled.
6. Press  to save and  to return to the previous screen.

### **Configuring Economizer**



If the equipment has an analog (between 0 to 10 V) input for an economizer damper command, configure the economizer as follows:

1. Press the Menu icon.
2. Press **Equipment Setup**.
3. Press **Economizer**.
4. Press **Economizer Installed** and select Yes.
5. Press **Min Position** and set to the percentage that the damper must be kept open to ensure fresh air flow in the zone.
6. Press **Closed Voltage** and set to the voltage output at which the damper is fully closed.
7. Press **Opened Voltage** and set to the voltage output at which the damper is fully opened.
8. Press  to save and  to return to the previous screen.

The TEC supports three methods of determining economizer availability. These are Dry Bulb, Single Enthalpy, and Dual Enthalpy, in increasing order of accuracy. To run an economizer, outdoor air temperature (OAT) is required to run in Dry Bulb mode. This can be provided by connecting a sensor to the OAT input on the TEC. It also can be provided by writing to NET-OAT from a Building Automation System (BAS), which overrides the internal sensor. If Outdoor Air Humidity (OAH) is also provided by writing to NET-OAH, then the single enthalpy method is used to determine if economizer cooling should be used. Finally, if Zone Humidity (ZNH) is also provided by writing to NET-ZNH, then the dual enthalpy method is used to determine if economizer cooling should be used.



All network overrides to the TEC work on a timeout basis. If the value is written to, it remains active as long as the BAS writes a new value within 15 minutes of the first one. If the 15-minute timeout occurs without getting any data written, the TEC stops using the network data

When operating in Dry Bulb or Single Enthalpy mode, it is necessary to provide a Dry Bulb Setpoint or an OA Enthalpy Setpoint, respectively. The TEC ships with default values set, but depending on climate it may be necessary to change these. To access these values:

1. Press the Menu icon.
2. Press **Equipment Setup**.
3. Press **Economizer**.
4. Press **Dry Bulb Setpoint** or **OA Enthalpy Setpoint** and adjust according.
5. Press  to save and  to return to the previous screen.

### ***Setting the Control Mode***

The Control Mode tells the controller to run in Cooling only, Heating only, or Automatic mode, based on the temperature in the zone relative to the heating and cooling setpoints. This setting does not override equipment lockouts, such as low or high outdoor temperature lockouts. To set the Control Mode:

1. Press the Menu icon.
2. Press **Control Setup**.
3. Press **General**.
4. Press **Control Mode** and select Cooling, Heating, or Auto as desired.
5. Press  to save and  to return to the previous screen.

### ***Setting the Fan Mode***

The Fan Mode informs the controller how to handle the fan. There are two options for fan configuration: a Fan Mode available to the installer through the menu system, and a fan override available as an option to the end user. See [Customizing the Home Screen](#) for information on enabling and disabling end-user controls. The Fan Mode icon on the home screen provides the following options:

- On – fan is continuously on
- Auto – fan cycles on demand with the stages of heating or cooling (continuous when free cooling with the economizer is running)
- Smart – fan cycles on demand with the stages of heating or cooling during unoccupied periods but is continuously running during occupied/standby periods



The Fan Override icon on the home screen provides the following options:

- On – overrides the fan to be continuously on
- Auto – follows the behavior set as Fan Mode





- Quiet – follows the behavior set as Auto Mode. The Quiet option has no effect on the RTU/heat pump equipment as only a single-speed fan is supported.

To set the Fan Mode:

1. Press the Menu icon.
2. Press **Control Setup**.
3. Press **General**.
4. Press **Fan Mode** and select On, Auto, or Smart.
5. Press  to save and  to return to the previous screen.

### **Temperature Setpoints**

The thermostat controller provides a flexible setpoint configuration to give power to the building owner while being easy to use by the occupant. In addition to a simple up/down offset adjustment on the home screen for the occupant, there are six temperature setpoints on the TEC. The six temperature setpoints are Cooling and Heating setpoints for Occupied, Unoccupied, and Standby modes. To set these setpoints:

1. Press the Menu icon.
2. Press **Setpoints**.
3. Select the desired setpoint to adjust and change as desired.
4. Press  to save and  to return to the previous screen.

**Note:** The TEC enforces a 2-degree deadband between heating and cooling setpoints. If a setpoint violates this standard (for example, cooling setpoint is set to 70 with a heating setpoint already set to 70), the opposing setpoint is modified to comply with this deadband (in the previous example, the heating setpoint would automatically change to 68).

The occupant has access to an up/down adjustment from the home screen. This adjustment applies a fixed offset (+/-) to the currently active setpoint, and this offset holds until the occupancy state of the controller changes. If the user taps the setpoint on the home screen, the icon inverts and displays white text on a black icon. The offset is held throughout all occupancy periods. For example, if the TEC is cooling in Occupied mode to an occupied cooling setpoint of 72 and you raise the setpoint 2 degrees to 74 from the home screen and then select hold, then the +2 degree offset persists through an occupancy change. If the occupancy then changes to unoccupied, with a setpoint of 80 degrees, the effective setpoint is 82 degrees. This allows the occupant to have a small amount of control over raising or lowering the temperature, but the building owner can still set back setpoints during standby and unoccupied periods. When the setpoint is in Hold mode, pressing the icon again releases the hold and immediately sets the setpoint offset back to 0.

### **Configuring Occupancy**

The TEC3000 controller supports a wide variety of occupancy sources to adapt to nearly any application.

- Local stand-alone weekly scheduler
- Remote schedule from BAS
- Occupancy sensor (internal or remote)
- Occupancy binary input (configurable)
- Manual occupancy override
- Temporary occupancy (by interacting with screen while unoccupied)
- Temporary occupancy binary input

Occupancy is determined using a top-down decision matrix as shown in Table 4.

Enumerations may not match the *TEC3000 Series On/Off or Floating Fan Coil and Zoning Thermostat Controllers with Dehumidification Capability Installation Instructions (Part No. 24-10787-6)*, *TEC3000 Series Proportional Fan Coil and Zoning Thermostat Controllers with Dehumidification Capability Installation Instructions (Part No. 24-10788-0)*, *TEC3000 Series Single- or Two-Stage Economizer Thermostat Controllers Installation Instructions (Part No. 24-10789-5)*, and *TEC3000 Series Field-Selectable BACnet MS/TP or N2 Networked Thermostat Controllers Technical Bulletin (LIT-12011956)* for NAE releases prior to 7.x.

**Table 4: Occupancy Determination**

Sequence of Operation (Highest to Lowest Priority)								
Occupancy Override Mode (OCCOVRD-MODE)	Occupancy BI (BI1-S, BI2-S) <sup>1</sup>	Temporary Occupancy <sup>2, 3</sup>	Occupancy Schedule (External or Schedule) (OCC-CONFIG, NET-OCC)	Motion Sensor <sup>4</sup>	Effective Occupancy (EFF-OCC)	Occupancy Source (OCCSOURCE-S)		
Occupied	–	–	–	–	Occupied-Override	Occ Override		
Unoccupied					Unoccupied-Override			
No Override	Closed <sup>1</sup>	–	–	–	Occupied	Occupancy BI		
	Open <sup>1</sup>				Unoccupied			
	Not Configured <sup>1</sup>	True <sup>2</sup>	NOT Occupied	NOT Occupied	–	Temp Occupancy	Temp Occ	
						True <sup>3</sup>	NOT Occupied	–
		False	Occupied	Occupied	True			
					False	Standby		
			Unoccupied	–	–	Disabled	Occupied	Occupancy Schedule
						Standby	Unoccupied	
		Not Set <sup>5</sup>	–	–	–	True	Occupied	Occupancy Sensor
						False	Unoccupied	
Disabled	Occupied					Occupancy Schedule		

1. Not Configured means that neither BI1 Config nor BI2 Config is set to Occupancy BI. Open and Closed refer to the current state of the BI when configured as Occupancy.
2. True is triggered by interacting with the screen during a scheduled unoccupied period. A value of True can only occur when the schedule is not Occupied.
3. When triggered by a BI configured for Temp Occ, the input is ignored when the schedule is Occupied, the Manual Occupancy Mode is **not** No Override, or an Occupancy BI is configured.
4. Built-in occupancy sensing (PIR) or EI configured for Motion NO or Motion NC.
5. Not Set occurs when no events are scheduled through the local scheduler, or the schedule source is set to Schedule and the Schedule is writing Not Set as the schedule.

## Selecting Schedule Source

### Scheduling

The TEC3000 thermostat controller can operate as a stand-alone unit with an internal schedule or scheduled with an external schedule. The OCC-CONFIG object sets the method used for scheduling.

If the OCC-CONFIG is set to External, the NET-OCC object is used to control the unit externally.

If the OCC-CONFIG is set to Schedule, the internal schedule commands the LOCAL-OCC object, which sets the Occupancy Schedule command.

**Note:** If you do not have a schedule in the Schedule object and you have the OCC-CONFIG set to Schedule, you can control the unit with the LOCAL-OCC object externally; however, we do not recommend this method. See Table 5 for scheduling information.



Once the Occupancy Schedule command is set, the effective occupancy is determined by settings shown in the Occupancy Determination table. See Table 4.

**Table 5: BAS Objects for Scheduling**

<b>BAS Objects for Scheduling</b>			
<b>OCC-CONFIG</b>	<b>LOCAL-OCC (Commanded by Internal Schedule)</b>	<b>NET-OCC</b>	<b>Occupancy Schedule Command<sup>1</sup></b>
External	Any State (Internal Schedule in Control)	Occupied	Occupied
		Unoccupied	Unoccupied
		Standby	Standby
		Not Set	Not Set
Schedule	Occupied	Not Applicable	Occupied
	Unoccupied		Unoccupied
	Standby		Standby
	Not Set		Not Set

1. The effective occupancy can be affected by other factors listed in Table 4.

The occupancy schedule can come from either the weekly scheduler built into the TEC or as an input from the BAS. The Schedule Source must be selected to tell the controller where to read the occupancy source from. To select the schedule source:

1. Press the Menu icon.
2. Press **Schedule**.
3. Press **Schedule Options**.
4. Press **Schedule Source** and select Schedule (Local) or External (BAS).
5. Press  to save and  to return to the previous screen.

This option is also exposed to the BAS through the point OCC-CONFIG. If BAS is configured as the occupancy source, map the point NET-OCC in and write to that point to control the schedule remotely. If the supervisor goes offline (as identified by the network icon going away on the home screen of the TEC), the control logic automatically falls back to the local schedule as the occupancy source. If that schedule is not set, the default occupancy is continuously occupied.

**Setting the Local Schedule**

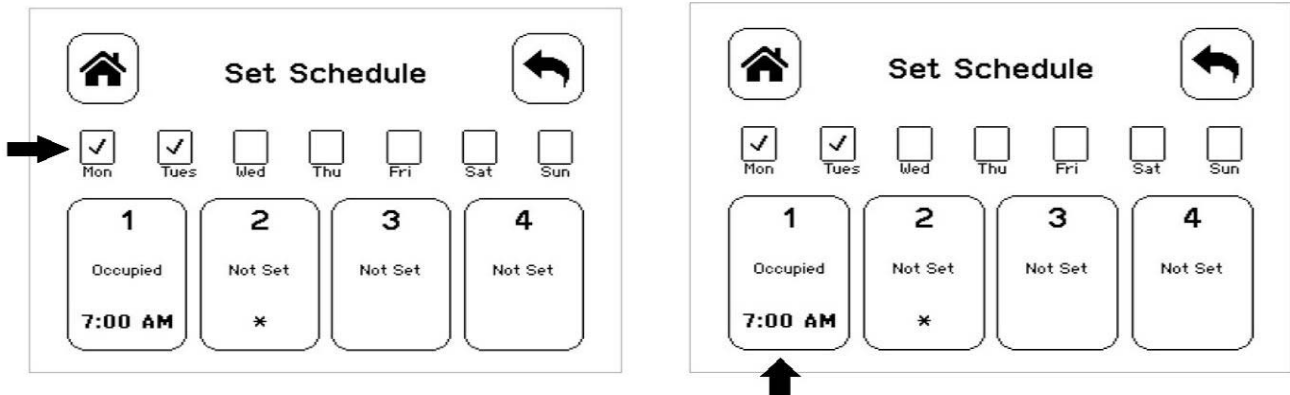
A weekly occupancy schedule with up to four occupancy events for each day can be set locally on the TEC and operate independently of a supervisor. To set the schedule:

1. See Selecting Schedule Source to ensure the schedule source is set to Local.
2. Press the Menu icon.
3. Press **Schedule**.
4. Press **Set Schedule**.

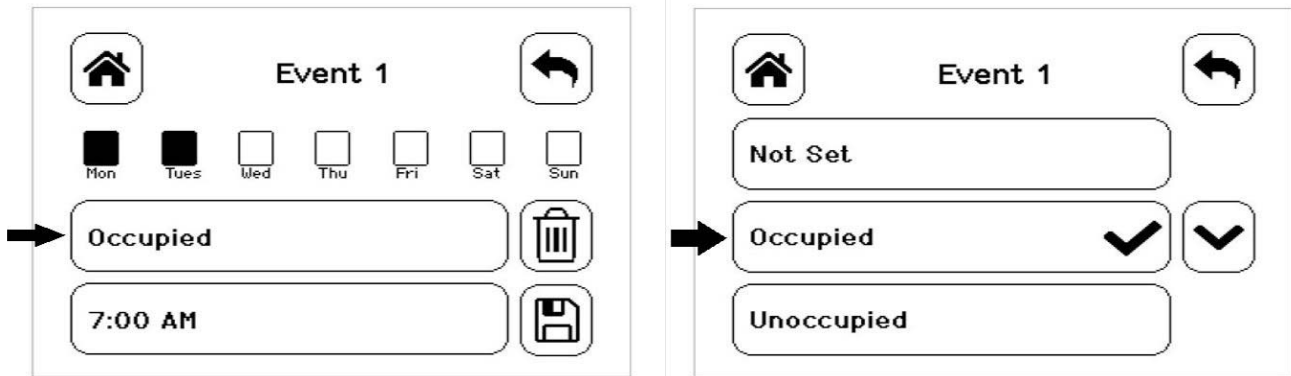
5. Select the days to which the schedule should apply. Note that if events are already set for the selected days, they appear in the corresponding event box. If any events conflict between selected days, an asterisk appears in the event box.
6. Select the event to be set.
7. Set the Occupancy to Not Set, Occupied, Unoccupied, or Standby and press **Save**.

**IMPORTANT:** Internally, the TEC 3000 uses a BACnet schedule where daily schedules are independent of the previous and next days. The default occupancy of the TEC3000 from the factory is set to Occupied. As a result, a daily event at 12:00 AM must be scheduled if you do not want the controller to transition to Occupied Mode at midnight.

**Figure 12: Selecting the Days (Left) and Selecting the Event (Right)**

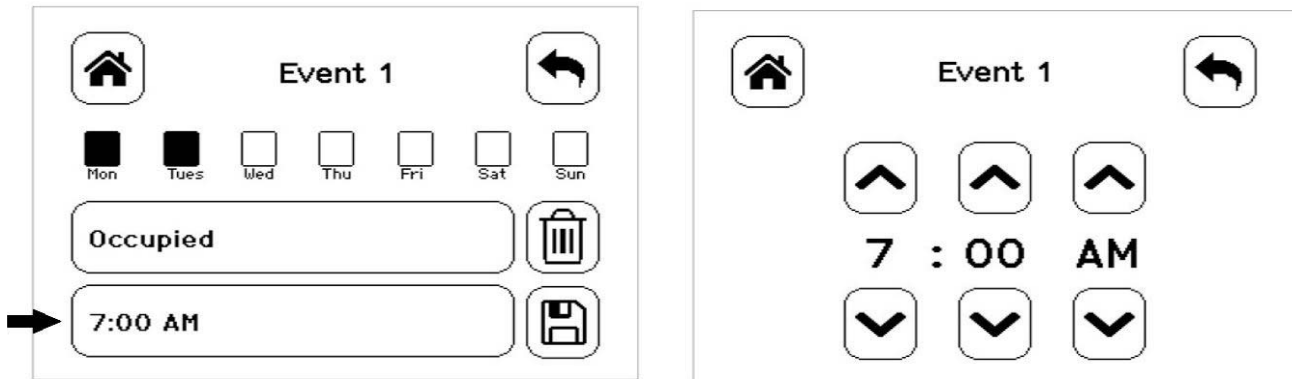


**Figure 13: Setting the Room Occupancy (Left) and Setting the Occupancy Mode (Right)**



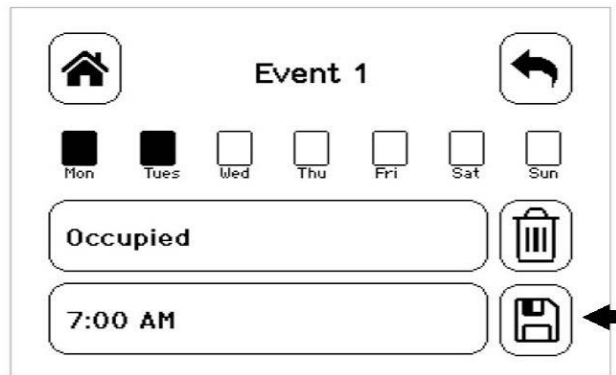
8. Set the time to the time at which the event should occur and press **Save**.

**Figure 14: Setting the Event Time (Left) and Viewing the Event Time (Right)**



9. Press **Save** to save the event and press the return icon to return to the main scheduler screen.

**Figure 15: Returning to the Main Menu**



10. Press  to save and  to return to the previous screen.

### ***Overriding the Occupancy Mode***

The TEC supports a manual override of all other schedule sources (for example, Schedule, Occupancy BI, and temporary occupancy). To override the Occupancy Mode:

1. Press the Menu icon.
2. Press **Schedule**.
3. Press **Schedule Options**.
4. Press **Manual Occupancy Mode** and select Occupied, Unoccupied, or No Override.

5. Press  to save and  to return to the previous screen.



This option is also exposed to the BAS through the point OCCOVRD-MODE.

### ***Enabling Optimal Start***

The TEC supports an advanced optimal start algorithm. The algorithm works in conjunction with a local schedule to pre-heat or pre-cool the zone before scheduled occupancy periods begin, in order to bring the zone to the desired occupied setpoint when the scheduled occupancy period begins. Occupant comfort is ensured while automatically minimizing energy usage. This algorithm creates a model of the zone being controlled and automatically determines when to start the equipment before the scheduled transition to Occupied. The start time automatically adjusts daily to minimize the time between reaching setpoint and entering Occupied state.



**Note:** Optimal Start does not work when the schedule source is set to External.

To enable this feature:

1. Press the Menu icon.
2. Press **Schedule**.
3. Press **Schedule Options**.
4. Press **Optimal Start Enable** and select Yes.
5. Press  to save and  to return to the previous screen.

### ***Enabling the Motion Sensor (TEC3x31-00-000 Models)***



By default on models with integral motion sensing capability, the motion sensor is enabled with a default timeout of 15 minutes from the last detection of motion in the zone. On models without an integrated sensor, the default timeout is still 15 minutes, but it only is applied when one of the two configurable binary inputs is set to be a motion sensor (see [Configurable Binary Inputs](#) for information on configuring the binary inputs). To disable motion sensing capabilities, set the Motion Sensor Timeout to 0 minutes. See Table 4 to view the available setpoints. See Table 7 to view the setpoint values. To adjust the motion sensor timeout:

1. Press the Menu icon.
2. Press **Schedule**.
3. Press **Schedule Options**.
4. Press **Motion Sensor Timeout** and adjust accordingly.
5. Press  to save and  to return to the previous screen.



### ***PID/PRAC+ Automatic Control Tuning***

The TEC3000 features advanced proportional-integral-derivative (PID) control algorithms to maximize control performance while minimizing excessive cycling and wear on the equipment. PID is used in conjunction with a Multi-Stage Controller (MSC) for all occupied and standby control.

Additionally, the PID features Johnson Controls proprietary PRAC+ (Pattern Recognition Adaptive Control) automatic tuning, which continuously tunes the controller parameters to automatically optimize the control performance to match the equipment and zone. By default, PRAC+ is enabled and immediately begins to tune. To reset tuning at any time to the factory defaults:

1. Press the Menu icon.
2. Press **Control Setup**.
3. Press **General**.
4. Press **Reset PID Tuning** and select Yes.
5. Press  to save and  to return to the previous screen.

PRAC+ automatic tuning can also be disabled. When disabled, the controller parameters remain at their last values until automatic tuning is re-enabled. To disable automatic tuning:

1. Press the Menu icon.
2. Press **Control Setup**.
3. Press **General**.
4. Press **Auto PID Tuning Enable** and select No.
5. Press  to save and  to return to the previous screen.

**Note:** For more details on PID/PRAC+ Automatic Control Tuning, refer to the *Controller Tool Help (LIT-12011147)*.

### **Configurable Binary Inputs**

The thermostat controller supports up to two configurable binary inputs (BIs) that can be used to add additional features to the system. Configurable Binary Inputs are accessed through **Settings > Control Setup > Inputs**. Both BIs can be configured to support the following options:

- Occupancy – Direct override of Occupied/Unoccupied
- Temp Occ – Trigger to place controller into Temporary Occupancy mode
- Motion NO – External motion sensor with an open contact output when no motion is detected
- Motion NC – External motion sensor with a closed contact output when no motion is detected
- Supply Fan Status – Input from the equipment to display a Supply Fan Fault. When Fan Alarm Action is set to Shutdown and the Supply Fan Fault is active, the TEC3000 disables the fan, heating, and cooling. When the Fan Alarm Action is set to Enable and the Supply Fan Fault is active, the TEC3000 allows the fan, heating, and cooling to operate during the Supply Fan Fault.
- Dirty Filter – Input from the equipment to display a dirty filter fault on the thermostat
- Service – Input from the equipment to display a service warning on the thermostat
- Fan Lock – Air Proof switch input to shut down control if no airflow is detected within 10 seconds of turning the fan on. Fan Lock must be manually reset from the Faults menu.
- Open Door – Works in conjunction with the Motion NO/Motion NC sensor to control occupancy
- Open Window – Sensor to shut down control if a window is opened. The controller disables control 60 seconds after detecting an opened window.
- Disabled – Sets the binary input to an unused state. When disabled, you can use the binary input for monitoring-only without affecting the thermostat functionality.

Setting both BIs to the same function is supported for all except Occupancy, Fan Lock, Open Door, and Open Window. If both BIs are set the same for those four, BI2 is ignored and only BI1 is used.

The Open Door option works in conjunction with a motion sensor, either built into the TEC or connected to another BI configured for Motion NO/NC mode. When the door is open, motion detected by the sensor is ignored. Note that opening the door does not stop an Occupied period started by the motion sensor prior to opening the door.

The polarity of the inputs are provided in Table 6.

**Table 6: Input Polarities (Part 1 of 2)**

<b>BI Configuration</b>	<b>Contact Open</b>	<b>Contact Closed</b>
<b>Occupancy</b>	Unoccupied	Occupied
<b>Temp Occ</b>	No Trigger Active	Temporary Occupancy Trigger <sup>1</sup>

**Table 6: Input Polarities (Part 2 of 2)**

BI Configuration	Contact Open	Contact Closed
Motion NO	No Motion Detected, Standby	Motion Detected, Occupied <sup>1</sup>
Motion NC	Motion Detected, Occupied <sup>1</sup>	No Motion Detected, Standby
Dirty Filter	Dirty Filter Alarm Inactive	Dirty Filter Alarm <sup>1</sup>
Service	Service Alarm Inactive	Service Alarm <sup>1</sup>
Fan Lock	No Airflow	Airflow
Open Door	Door Open, Unoccupied	Door Closed, Occupied
Open Window	Window Open, Control Shut Down	Window Closed, Control Running
Supply Fan Status	Supply Fan Off	Supply Fan On



1. Configurations that support both BIs configured for the same feature of the action that occurs when either of the BIs enter that state.

### **Aux Control**

The TEC has an auxiliary output that can be configured to operate in a few different ways. The Aux Mode supports seven different options:

- Not Used – Output is always off
- Occupied NO – Output is normally open, but closes when occupied
- Occupied NC – Output is normally closed, but opens when occupied
- Occupied Fan NO – Output is normally open, but is closed when occupied with the fan running
- Occupied Fan NC – Output is normally closed, but is open when occupied with the fan running
- On – Output is turned on (relay closed), used by a BAS to directly control the AUX output
- Off – Output is turned off (relay open), used by a BAS to directly control the AUX output

To set the Aux Mode:

1. Press the Menu icon.
2. Press **Control Setup**.
3. Press **General**.
4. Press **Aux Mode** and set accordingly.
5. Press  to save and  to return to the previous screen.

This option is also exposed to the BAS through the point AUX-MODE.

### **Commissioning Mode**

The thermostat controller has a built-in commissioning mode, which is designed to allow you to quickly test equipment wiring and functionality. Commissioning mode temporarily disables the control logic, and allows you to manually command any individual output. Commissioning is designed to be the last step of the installation process after configuring the controller for the equipment being controlled, and the available options in commissioning mode are dependent on the controller configuration. To enter commissioning mode:

1. Press the Menu icon.
2. Select Commissioning.
3. Confirm that the selection was intentional. (The control is overridden upon selecting Confirm).



Individual outputs can be commanded through this interface. For binary outputs, the options are Off or On; for analog outputs, they can be commanded from 0 to 100%. Whenever a control output is turned on, the fan is engaged for safety purposes. To command an output from the Commissioning menu:

1. Select the output to command. Adjust the value to the desired output and press **Save**. The output immediately changes to that value.
2. Restore the value to the original setting and press **Save** once again to complete testing that output.

Pressing the back icon from the main commissioning menu or allowing the menu system to time out and return to the home screen ends commissioning and puts the control logic back in control of the outputs.

### **Sensor Priority**

The TEC3000 supports various sources of sensor data for use in control or display, including internal sensors, remote sensors (connected using an analog input), or network commanded sensors. The TEC uses the highest priority connected input (network commands followed by remote sensors and then internal sensors) for control and display. Not all sources are available for all sensors.

Network commands operate on a timeout basis. When a network point is written to by a supervisor, the point becomes the highest priority for 15 minutes. If a new update is written within 15 minutes, the timer is restarted for another 15 minutes.

### **Available Fault Diagnostics**

- Supply Fan Faults – The TEC3000 supports a configurable Supply Fan Status feedback input that turns on when the Supply Fan Status does not match the Supply Fan Command, and can be configured to disable heating, cooling, and fan commands. The alarm delay is adjustable through the Fan Alarm delay setting. If the delay is set to 0 or the binary input is not defined, this feature becomes disabled.
- Supply Fan Runtime – The TEC3000 supports setting runtime limits on the supply fan command. When the limit is exceeded, an alarm turns on. This feature is intended to be used as a maintenance reminder. Setting the runtime limit to 0 disables this feature.
- Supply Air Temperature Diagnostics – The TEC3000 supports diagnostics when you have a Supply Air Temperature installed. The TEC3000 monitors the supply air. If you call for cooling or heating and the temperature does not fall or rise by at least the supply air temperature alarm offset value within the supply air temperature alarm delay, an alarm is generated. If the monitoring occurs while cooling, a cooling ineffective alarm is generated. If the monitoring occurs while heating, a heating ineffective alarm is generated. If you set the supply air temperature offset value set to 0, this alarm is disabled.
- Zone Temperature Alarm – When enabled, the user can set a low and high temperature alarm; and if the zone temperature rises or falls below those limits, an alarm is generated.
- Trends – Built-in trends exist for many of the inputs and outputs for the TEC3000. These trends are viewable at the TEC. The analog graph displays data in 15 minute increments over the previous 24 hours or a table with the last 25 data points. Binary trends display 25 samples taken at every change of state.

### **Menus and Submenus**

In the following table, the \* indicates that the menus depend on your configuration.

**Table 7: Menus and Submenus (Part 1 of 6)**

<b>Level 1</b>	<b>Level 2 (LCD Screen Name)</b>	<b>Level 3 (Default Values)</b>	<b>Available Values</b>
<b>Setpoints</b>	Occ Cooling Setpoint	72°F (22°C)	55 to 85°F (13 to 30°C)
	Occ Heating Setpoint	68°F (20°C)	55 to 85°F (13 to 30°C)
	Unocc Cooling Setpoint	80°F (27°C)	55 to 85°F (13 to 30°C)
	Unocc Heating Setpoint	60°F (15°C)	55 to 85°F (13 to 30°C)
	Stby Cooling Setpoint	74°F (23°C)	55 to 85°F (13 to 30°C)
	Stby Heating Setpoint	66°F (19°C)	55 to 85°F (13 to 30°C)

**Table 7: Menus and Submenus (Part 2 of 6)**

Level 1	Level 2 (LCD Screen Name)	Level 3 (Default Values)	Available Values
<b>Schedule</b>	<b><i>Schedule Options</i></b>		
	Set Schedule		See <i>Scheduling</i>
	Optimal Start Enable	No	Yes or No
	Temp Occ Duration	120 minutes	0 to 300 minutes
	Motion Sensor Timeout	15 minutes	15 to 240 minutes
	Manual Occupancy Mode*	No Override	No Override, Occupied, Unoccupied
	Schedule Source*	Local	Local or BAS
<b>Display Settings</b>	Passcode Enable	No	Yes or No
	Passcode*	NA	0000 to 9999 *Passcode Enable = Yes
	Brightness Setting	8	0 to 10 (most dim to brightest)
	Enable Backlight Timeout	Yes	Yes/No
	Units	IP	IP or SI
	Time	N/A	
	Time Zone	Central	All World Time Zones
	Set Time Format	24 hour	24 hour or 12 hour
	Date	N/A	
	Set Date Format	YYYY-MM-DD	YYYY-MM-DD, or Day, Month DD, YYYY, or MM-DD-YYYY
	Language	English	English, French, Spanish
	Show Fan Icon	Yes	Yes or No
	Show Temp	Yes	Yes or No
	Show Humidity	Yes	Yes or No
	Show Off Icon	Yes	Yes or No
	Show Hold Icon	Yes	Yes or No
	Show Setpoint	Yes	Yes or No
	Show Alarms	Yes	Yes or No
	Show Occ Status	Yes	Yes or No
Show Unit Status	Yes	Yes or No	
Show Date/Time	Yes	Yes or No	
<b>Control Setup</b>	<b><i>General</i></b>		
	Control Mode	Auto	Auto, Cooling, or Heating
	Unit Enable	Enable	Enable or Shutdown
	Fan Mode	Smart	Not Used, On, Auto, Smart
	Max Setpoint Offset	3	0 to 20 degrees (°F or °C based on Units setting under Display Settings menu)
	Fan On Delay	30 seconds	0 to 120 seconds
	Fan Off Delay	30 seconds	0 to 120 seconds
	Frost Protection	Yes	Yes or No
	Reset PID Tuning*	No	Yes or No
Auto PID Tuning Enable	Yes	Yes or No	

**Table 7: Menus and Submenus (Part 3 of 6)**

Level 1	Level 2 (LCD Screen Name)	Level 3 (Default Values)	Available Values	
<b>Control Setup (Cont.)</b>	Aux Mode	Not Used	Not Used, Occupied NO, Occupied NC, Occupied Fan NO, Occupied Fan NC, On, Off	
	Load Shed Rate Limit	0.066°F	0 to 1°F (0 to 0.5°C)	
	Load Shed Adjust	4°F	0 to 8°F (0 to 4°C)	
	Fan Alarm Delay	0 seconds	0 to 300 seconds	
	Fan Alarm Action (when Fan Alarm Delay is greater than 0)	Enable	Enable or Shutdown	
	Fan Alarm Reset (when Fan Alarm Delay is greater than 0)	No	Yes or No	
	Fan Runtime Limit	0 hours	0 to 9,000 hours	
	Fan Runtime Reset (when Fan Runtime Limit is greater than 0)	No	Yes or No	
	Supply Air Temperature Alarm Offset	0°F	0 to 10°F (0 to 5.5°C)	
	Supply Air Temperature Alarm Delay (when Supply Air Temp Alarm Offset is greater than 0)	300 seconds	300 to 3,600 seconds	
	<b>Inputs</b>			
	BI1 Config	Disabled	Disabled, Occupancy, Occupancy Override, Remote PIR, Dirty Filter, Service, Fan Lock, Open Door, Open Window	
	BI2 Config	Disabled	Disabled, Occupancy, Occupancy Override, Remote PIR, Dirty Filter, Service, Fan Lock, Open Door, Open Window	
	Supply Temp Sensor	Nickel	Nickel, Platinum, A99B, 2.25k ohm negative temperature coefficient (NTC), 10k ohm NTC, 10k ohm NTC Type 3	
	Supply Temp Offset	0	-5 to 5 (°F or °C based on Units setting under Display Settings menu) * Analog Sensor	
	Zone Temp Sensor	Nickel	Nickel, Platinum, A99B, 2.25k ohm NTC, 10k ohm NTC, 10k ohm NTC Type 3	
	Zone Temp Offset	0	-5 to 5 (°F or °C based on Units setting under Display Settings menu)	
	OA Temp Offset	0	-5 to 5 (°F or °C based on Units setting under Display Settings menu)	
	OA Temp Sensor	Nickel	Nickel, Platinum, A99B, 2.25k ohm NTC, 10k ohm NTC, 10k ohm NTC Type 3	
	Reset Sensors	False	True or False	
	Zone Temp Alarm Enabled	No	Yes or No	
Zone Temp Low Limit	55°F	32 to 150°F (0 to 65.56°C)		
Zone Temp High Limit	90°F	32 to 150°F (0 to 65.56°C)		
<b>Network Setup</b>	FC Comm Mode	BACnet/MSTP	BACnet/MSTP, N2	
	BACnet Instance ID*	1	0 to 4,914,302 * BACnet/MSTP communication mode	

**Table 7: Menus and Submenus (Part 4 of 6)**

Level 1	Level 2 (LCD Screen Name)	Level 3 (Default Values)	Available Values
<b>Network Setup (Cont.)</b>	N2 Device Address*	4	1 to 255 * N2 Communication mode
	BACnet Device Address*	4	4 to 127 * BACnet/MSTP communication mode
	MSTP Baud Rate*	Auto	Auto, 1200, 9600, 19200, 38400, 76800 * BACnet/MSTP communication mode
	BACnet Encoding Type BACnet/MSTP Communication Mode	ISO 10646 (UCS-2)	ISO 10646 (UCS-2), ANSI X3.4 (US-ASCII)
<b>Equipment Setup</b>	<b>General</b>		
	Number of Compressor	One-Stage	Not Used, One-Stage, Two-Stage
	Lead/Lag Equalize Runtime	No	Yes or No
	Number of Heating Stages*	Two-Stage	Not Used, One-Stage, Two-Stage * Heat pump unit, Heat Pump supported = False
	Compressor Min On Time	180 seconds	0 to 360 seconds
	Compressor Min Off Time	180 seconds	0 to 360 seconds
	Heating Min On Time	120 seconds	0 to 360 seconds * Heat pump unit, Heat Pump supported = False
	Heating Min Off Time	120 seconds	0 to 360 seconds * Heat pump unit
	Supp Min On Time	120 seconds	0 to 360 seconds * Heat pump unit, Supp Heating Installed = True
	Supp Min Off Time	120 seconds	0 to 360 seconds * Heat pump unit, Supp Heating Installed = True
	Cooling Lockout Temp	40°F (4°C)	0 to 100°F (-18 to 38°C)
	Heating Lockout Temp	80°F (27°C)	0 to 100°F (-18 to 38°C)
	<b>Economizer*</b>		
	Economizer Installed	False	True or False
	Economizer Min Pos*	20%	0 to 100% *Economizer = True
	Closed Voltage*	2 VDC	0 to 10 VDC *Economizer = True
	Open Voltage*	10 VDC	0 to 10 VDC *Economizer = True
	Dry Bulb Setpoint	68°F (20°C)	0 to 100°F (-18 to 38°C) *Economizer = True
	Outdoor Enthalpy Setpoint	27 Btu/lb	0 to 100 Btu/lb dry air *Economizer = True
	<b>Heat Pump*</b>		
	Heat Pump Supported	False	True or False
	Supp Heating Installed*	True	True or False * Heat Pump supported = True

**Table 7: Menus and Submenus (Part 5 of 6)**

<b>Level 1</b>	<b>Level 2 (LCD Screen Name)</b>	<b>Level 3 (Default Values)</b>	<b>Available Values</b>
<b>Equipment Setup (Cont.)</b>	Comp Low Lockout Temp*	32°F (0°C)	-20 to 100°F (-29 to 38°C) * Supp Heating Installed = True
	Supp High OA Lockout Temp*	50°F (10°C)	-20 to 100°F (-29 to 38°C) * Supp Heating Installed = True
	Rev Valve Polarity*	Normally Heat	Normally Heat, Normally Cool
<b>Trend</b>	EFF-ZNT		-50 to 250°F (-45.56 to 121.11°C)
	EFF-SETPOINT		45 to 100°F (7.22 to 37.78°C)
	EFF-ZNH		0 to 100%RH
	B1 Status		On or Off
	B2 Status		On or Off
	EFF-OAT		-50 to 250°F (-45.56 to 121.11°C)
	EFF-SAT		-50 to 250°F (-45.56 to 121.11°C)
	FANSPD-S		On or Off
	CLG1-C		On or Off
	CLG2-C		On or Off
	HTG1-C		On or Off
	HTG2-C		On or Off
	OAD-O		0 to 100%
	HTG-O		0 to 100%
	CLG-O		0 to 100%
<b>System Status</b>	Occupancy Source	Occupancy Sensor	Occupancy BI Temp Occ BI Temp Occ Occ Override Local Schedule BAS Schedule Occupancy Sensor
	Unit Status	Idle	System Fault Airflow Fault Open Window Control Off Unreliable Temperature Dehumidification Idle Cooling Heating Cooling Unavailable Heating Unavailable Cooling Unavailable due to Changeover Cooling Unavailable due to OA Temp Cooling Unavailable due to Control Mode Heating Unavailable due to Changeover Heating Unavailable due to OA Temp Heating Unavailable due to Control Mode
	Supply Air Temperature	75°F	-50 to 250°F (-45 to 121°C)

**Table 7: Menus and Submenus (Part 6 of 6)**

<b>Level 1</b>	<b>Level 2 (LCD Screen Name)</b>	<b>Level 3 (Default Values)</b>	<b>Available Values</b>
<b>System Status (Cont.)</b>	Cooling OAT Lockout	Inactive	Active or Inactive
	Heating OAT Lockout	Inactive	Active or Inactive
	Comp Low OAT Lockout	Inactive	Active or Inactive
	Supp High Lockout Temp	Inactive	Active or Inactive
	Zone Temp Source	Internal Sensor	Unreliable Internal Sensor Remote Sensor Network Override Input Not Installed
<b>Control Status</b>	Cooling % Command		0 to 100%
	Heating % Command		0 to 100%
	Supplemental % Command		0 to 100%
	Supplemental Heat Command	Off	On or Off
	Fan	On	On or Off
<b>Controller Info</b>	Model Name	TEC3x3x-xx	–
	Software Version	x.x.x.xxxx	–
	Unit Name	TECxxxxx	–
	Device Name		User-Supplied
	Device Description	TEC3000	–
<b>Commissioning</b>	Supply Air Temperature	Display Current Temperature	–
	Heat Command	0%	0 to 100%
	Cool Command	0%	0 to 100%
	Supply Fan	No	Yes or No
	Aux	No	Yes or No
<b>Update</b>	View Version	x.x.x.xxxx	Current Release of Software
	Load Firmware		File list from USB drive
	Restore		File list from USB drive or local storage <sup>1</sup>
	Backup		File list from USB drive or local storage <sup>1</sup>

1. Configuration can be backed up to the USB drive and restored to similar models to expedite the commissioning process.

## Troubleshooting

**Table 8: Fault List (Part 1 of 3)**

<b>Faults</b>	<b>Probable Causes</b>	<b>Solutions</b>
<b>Remote Zone Temp Fail</b>	The External Zone Temperature sensor has been disconnected or has failed.	<ol style="list-style-type: none"> <li>1. Check the wiring of the sensor.</li> <li>2. If intentionally disconnected, reset sensors through the menu.</li> <li>3. If the problem persists, order replacement units and return the affected devices to Johnson Controls under the RMA program.</li> </ol>
<b>Supply Temp Fail</b>	The External Supply Temperature sensor has been disconnected or has failed.	<ol style="list-style-type: none"> <li>1. Check the wiring of the sensor.</li> <li>2. If intentionally disconnected, result fault by entering the menu, enter Control Setup, and select Inputs to reset the sensors.</li> <li>3. If the problem persists, order replacement units and return the affected devices to Johnson Controls under the RMA program.</li> </ol>
<b>Outdoor Temp Fail</b>	The External Outdoor Air Temperature sensor has been disconnected or has failed.	<ol style="list-style-type: none"> <li>1. Check the wiring of sensor.</li> <li>2. If intentionally disconnected, reset sensors through the menu.</li> <li>3. If the problem persists, order replacement units and return the affected devices to Johnson Controls under the RMA program.</li> </ol>
<b>Internal Sensor Fail</b>	An internal sensor has failed on the TEC.	Order replacement units and return the affected devices to Johnson Controls under the RMA program.
<b>OA Lockouts Disabled</b>	The Local Outdoor Air Temperature sensor has become disconnected or failed or a network Outdoor Air Temperature sensor has timed out, and the TEC is no longer shutting down equipment based on the OA lockout setpoints.	<ol style="list-style-type: none"> <li>1. If the source of outdoor air temperature was a locally connected sensor, follow the steps for the Outdoor Temp Fail alarm.</li> <li>2. If the source of outdoor air temperature was a BAS, check the BAS to ensure that it is still online and is providing the TEC with the temperature reading. If removal of the BAS mapping was intentional, reset sensors through the menu.</li> </ol>
<b>Econ Unavailable</b>	The Outdoor Air Temperature sensor is not installed, has failed, or has been disconnected and the TEC can no longer control the economizer.	Follow the same steps as Outdoor Temp Fail alarm.
<b>Dehum Unavailable</b>	Dehumidification is unavailable because the zone humidity sensor has failed or the humidity reading is not reliable.	<ol style="list-style-type: none"> <li>1. If the source of zone humidity was a BAS, check the BAS to ensure that it is still online, and providing the TEC with the humidity reading. If removal of the BAS mapping was intentional, reset the sensors through the menu.</li> <li>2. If the problem persists, order replacement units and return the affected devices to Johnson Controls under the RMA program.</li> </ol>
<b>Service</b>	Equipment connected to the BI configured for a Service alarm is triggering the alarm.	Service the equipment by way of the manufacturer's recommendation.
<b>Dirty Filter</b>	Equipment connected to the BI configured for a Dirty Filter alarm is triggering the alarm.	Replace the filter in the equipment as explained in the manufacturer's instructions.
<b>Calibration Corrupt</b>	Factory calibration data is lost or is not installed.	Order replacement units and return the affected devices to Johnson Controls under the RMA program.

**Table 8: Fault List (Part 2 of 3)**

<b>Faults</b>	<b>Probable Causes</b>	<b>Solutions</b>
<b>Zone Temp Unreliable</b>	All sources of zone temperature are unreliable, including the onboard sensor.	Order replacement units and return the affected devices to Johnson Controls under the RMA program.
<b>Open Window</b>	The switch connected to the BI configured for Open Window is sensing that the window is opened, and control has shut down.	<ol style="list-style-type: none"> <li>1. Close the window to resume control.</li> <li>2. Check sensor functionality with an ohmmeter, and verify the wiring to the TEC.</li> <li>3. Order replacement units and return the affected devices to Johnson Controls under the RMA program.</li> </ol>
<b>Fan Lock</b>	The switch connected to the BI configured for Fan Lock did not sense airflow within 10 seconds of starting the fan, and control has been shut down.	<ol style="list-style-type: none"> <li>1. Inspect equipment to ensure fan functions.</li> <li>2. Check sensor functionality with an ohmmeter, and verify wiring to the TEC.</li> <li>3. Reset fault by entering the menu, selecting Fault Status, and selecting the Fan Lock.</li> <li>4. If problems persist, order replacement units and return the affected devices to Johnson Controls under the RMA program.</li> </ol>
<b>Humidity Unreliable</b>	The zone humidity reading was reliable and has now failed.	<ol style="list-style-type: none"> <li>1. If the source of zone humidity was the onboard sensor, contact Johnson Controls product sales and support.</li> <li>2. If the source of zone humidity was a BAS, check the BAS to ensure that it is still online and providing the TEC with the humidity reading. If removal of the BAS mapping was intentional, reset sensors through the menu.</li> </ol>
<b>Controller Fault</b>	The controller has detected an internal fault that it cannot recover.	Order replacement units and return the affected devices to Johnson Controls under the RMA program.
	An unknown error has prevented the controller from turning on.	Order replacement units and return the affected devices to Johnson Controls under the RMA program.
<b>Touchscreen Unavailable</b>	The touchscreen components have failed to initialize.	<ol style="list-style-type: none"> <li>1. Reboot the controller.</li> <li>2. If problems persist, order replacement units and return the affected devices to Johnson Controls under the RMA program.</li> </ol>
<b>Board Mismatch</b>	The baseboard and CPU board are paired incorrectly. An error message appears on the TEC indicating the model number of the baseboard and CPU board.	Match the baseboard to its corresponding CPU board. See Figure 5 for information on ensuring that you have the CPU board and base board paired correctly.
<b>USB Malfunction</b>	A USB drive has malfunctioned and drawn more than the maximum allowed current.	<ol style="list-style-type: none"> <li>1. Attempt to insert and use the USB drive again.</li> <li>2. Try a new USB drive.</li> <li>3. If problems persist, order replacement units and return the affected devices to Johnson Controls under the RMA program.</li> </ol>
<b>Supply Fan Runtime Limit Extended</b>	The Supply Fan Runtime has exceeded the configured Supply Fan Runtime Limit.	<ol style="list-style-type: none"> <li>1. Service the Supply Fan.</li> <li>2. Reset the Supply Fan runtime.</li> </ol>
<b>Heating Ineffective</b>	The Supply Air Temperature has not increased above the configured Supply Air Temperature Alarm Offset while heating has been active for at least the Supply Air Temperature Alarm Delay.	Verify that the heating elements on the rooftop are functioning properly.



**Table 8: Fault List (Part 3 of 3)**

<b>Faults</b>	<b>Probable Causes</b>	<b>Solutions</b>
<b>Cooling Ineffective</b>	The Supply Air Temperature has not decreased below the configured Supply Air Temperature Alarm Offset while cooling has been active for at least the Supply Air Temperature Alarm Delay.	Verify that the cooling elements on the rooftop are functioning properly.
<b>Supply Fan Fault</b>	The Supply Fan Status configured for either BI1 or BI2 has not proved within the configured Fan Alarm Delay.	<ol style="list-style-type: none"> <li>1. Verify that the Supply Fan is operating when turned on.</li> <li>2. Verify that the Supply Fan Status wiring is connected correctly.</li> </ol>
<b>Zone Temperature Too Cold</b>	The Zone Temperature has decreased below the configured Zone Temp Low Limit.	Verify that the TEC and the RTU heating are enabled and functioning.
<b>Zone Temperature Too Hot</b>	The Zone Temperature has increased above the configured Zone Temp High Limit.	Verify that the TEC and the RTU cooling are enabled and functioning.

**Table 9: Troubleshooting Details<sup>1</sup> (Part 1 of 3)**

<b>Symptom</b>	<b>Probable Causes</b>	<b>Solutions</b>
The controller displays <b>Idle</b> with a <b>Unit Status of Cooling Unavailable due to OA Temp</b> despite being above cooling setpoint, or with a status of <b>Heating Unavailable due to OA Temp</b> despite being below the setpoint.	The outdoor air temperature is too warm for heating or too cold for cooling.	<ol style="list-style-type: none"> <li>1. If Cooling and Heating Lockout Setpoints are inadequate, adjust the setpoints.</li> <li>2. Wait for the outdoor conditions to be favorable for heating or cooling.</li> </ol>
The controller displays <b>Idle</b> with a <b>Unit Status of Cooling Unavailable due to Control Mode</b> despite being above cooling setpoint, or with a status of <b>Heating Unavailable due to Control Mode</b> despite being below the setpoint.	The Control Mode is set to Cooling Mode, but the controller is requesting heating.	Change the Control Mode to Auto or Heating.
	The Control Mode is set to Heating Mode, but the controller is requesting cooling.	Change the Control Mode to Auto or Cooling.
The controller displays <b>Idle</b> with a <b>Unit Status of Cooling Unavailable</b> despite being above cooling setpoint, or with a status of <b>Heating Unavailable</b> despite being below the setpoint.	The Number of Compressors set to Not Used and the controller is requesting cooling, or Number of Heating Stages is set to Not Used.	Adjust the number of compressors and number of heating stages to match the configuration of the unit.
The heat pump does not sequence properly.	The heat pump requires traditional wiring (Y1, Y2, W1, W2, and G) and handles the reversing valve internally, but Heat Pump Supported is set to Yes.	Consult the equipment documentation to verify wiring configuration, then set Heat Pump Supported to No.
	The heat pump requires thermostat to control the reversing valve (Y1, Y2, O/B, and G) but the Heat Pump Supported is set to No.	Consult the equipment documentation to verify wiring configuration, then set Heat Pump Supported to Yes.
The heat pump heats when it should be cooling, and cools when it should heat.	Reversing Valve polarity is incorrectly set.	Consult the equipment documentation to verify reversing valve polarity, then adjust the Reversing Valve Polarity menu option accordingly.
The controller displays <b>Cooling</b> or <b>Heating</b> , but the staged equipment shuts off.	When in heating or cooling mode with staged equipment, the equipment cycles on and off during the cooling or heating operation in order to maintain setpoint.	Expected behavior.

**Table 9: Troubleshooting Details<sup>1</sup> (Part 2 of 3)**

Symptom	Probable Causes	Solutions
The staged equipment shuts off above the cooling setpoint or below the heating setpoint.	The PID control algorithm minimizes overshoot and energy usage for the particular equipment and zone, and may cycle the equipment prior to reaching setpoint.	Expected behavior.
The staged equipment cycles too rapidly or too slowly.	The control band around the setpoint is determined by the minimum on/off times and is set incorrectly for the equipment, zone, or user preference. There is a tradeoff between reduced control band size and increased energy usage and equipment wear from increased cycling.	<ol style="list-style-type: none"> <li>To tighten the control band, reduce the minimum on/off time settings. Minimal control band is achieved with a 60-second minimum on and off time.</li> <li>To loosen the control band, increase the minimum on and off time settings.</li> </ol>
The controller provides an error when trying to upgrade firmware.	The USB drive is defective.	Try a different USB drive.
	The firmware package is corrupt.	Try re-downloading the firmware image onto the USB drive and retry the upgrade.
The controller provides an error when trying to back up settings.	The USB drive is defective.	Try a different USB drive.
The controller provides an error when trying to restore settings from a backup.	The USB drive is defective.	Try a different USB drive.
	The Restore file is corrupt.	Try restoring a different backup file.
	The Restore file is from an incompatible model TEC.	Ensure that the backup file being restored was from the same model TEC.
The controller is unable to access a USB drive.	The drive is formatted as NTFS or another unsupported format. The TEC supports FAT and FAT32 formats only.	Reformat the USB drive, or try a different USB drive with a supported format.
	The USB drive is defective.	Try a different USB drive.
The controller displays <b>Board Mismatch</b> .	The I/O board that the display board is currently attached to does not match the one that initially shipped with the display board.	Attach the display board to the correct I/O board.
	A hardware failure is causing the two boards to incorrectly identify themselves.	Order replacement units and return the affected devices to Johnson Controls under the RMA program.
The controller displays <b>Controller Fault</b> .	An internal fault was detected and the controller was unable to recover.	Order replacement units and return the affected devices to Johnson Controls under the RMA program.
The Bell icon is displayed on the TEC home page.	The fault has been detected on the TEC.	See Table 8 for TEC fault causes and resolution.
<b>Partial Restore Complete</b> is displayed when trying to restore settings from a backup file.	Not all of the items in the backup file have been restored. This error can be caused by a value being out of the minimum or maximum range in the backup file. It may also occur if there are inconsistencies in the reliability of a setting in the backup file and on the TEC device.	<ol style="list-style-type: none"> <li>Create a Backup file on a USB drive for the TEC that is showing the issue.</li> <li>Edit the backup file created in step 1 on a PC to reflect the desired settings.</li> <li>Verify that the modified values are within minimum and maximum range in the backup file.</li> <li>Restore the settings from the newly edited backup file on the TEC.</li> </ol>

**Table 9: Troubleshooting Details<sup>1</sup> (Part 3 of 3)**

Symptom	Probable Causes	Solutions
The temperature displayed is lower than the actual room temperature.	Cold air drafts are entering the back of the TEC.	Seal any holes behind the TEC to reduce drafts.
The Online icon does not appear for a networked controller.	There is improper field bus wiring.	Refer to the <i>MS/TP Communications Bus Technical Bulletin (LIT-12011034)</i> .


- For common MS/TP troubleshooting information, refer to the *MS/TP Communications Bus Technical Bulletin (LIT-12011034)*.

## Repair Information

If the TEC3000 Series Thermostat Controller fails to operate within its specifications, replace the unit. For a replacement thermostat controller, contact the nearest Johnson Controls representative.

## Technical Specifications

### ***TEC3000 Series Single- or Two-Stage Economizer Thermostat Controllers (Part 1 of 2)***

<b>Power Requirements</b>		19 to 30 VAC, 50/60 Hz, 4 VA at 24 VAC nominal, Class 2 or safety extra-low voltage (SELV)
<b>USB Port Power Rating</b>		120 to 250 mA current draw supported
<b>Relay Contact Rating</b>		19 to 30 VAC, 1.0 A maximum, 15 mA minimum, 3.0 A in-rush, Class 2 or SELV
<b>Binary Inputs</b>		Voltage free contacts across terminal COM to terminals BI1 or BI2
<b>Analog Inputs</b>		Nickel, platinum, A99B, 2.25k ohm NTC, 10k ohm NTC, 10k ohm NTC Type 3 across terminal COM to terminals R SEN
<b>Temperature Sensor Type</b>		Local 1k ohm platinum sensor
<b>Wire Size</b>		18 AWG (1.0 mm diameter) maximum, 22 AWG (0.6 mm diameter) recommended
<b>MS/TP Network Guidelines</b>		Up to 100 devices maximum for each Network Automation Engine (NAE); 4,000 ft (1,219 m) maximum cable length
<b>Temperature Range</b>	<b>Backlit Display</b>	-40.0°F/-40.0°C to 122.0°F/50.0°C in 0.5° increments
	<b>Heating Control</b>	40.0°F/4.5°C to 90.0°F/32.0°C
	<b>Cooling Control</b>	54.0°F/12.0°C to 100.0°F/38.0°C
<b>Accuracy</b>	<b>Temperature</b>	±0.9F°/±0.5C° at 70.0°F/21.0°C typical calibrated
<b>Minimum Deadband</b>		2F°/1C° between heating and cooling
<b>Occupancy Sensor Motion Detection (Occupancy Sensing Models)</b>		Minimum of 94 angular degrees up to a distance of 15 ft (4.6 m); based on a clear line of sight
<b>Ambient Conditions</b>	<b>Operating</b>	32 to 122°F (0 to 50°C); 95% RH maximum, noncondensing
	<b>Storage</b>	-22 to 122°F (-30 to 50°C); 95% RH maximum, noncondensing
<b>Compliance</b>  	<b>BACnet International</b>	BACnet Testing Laboratories™ (BTL) 135-2001 Listed BACnet Application Specific Controller (B-ASC)
	<b>United States</b>	UL Listed, File E27734, CCN XAPX, Under UL60730
		FCC Compliant to CFR 47, Part 15, Subpart B, Class B
	<b>Canada</b>	UL Listed, File E27734, CCN XAPX7, Under E60730
		Industry Canada, ICES-003
<b>Europe</b>	CE Mark – Johnson Controls declares that this product is in compliance with the essential requirements and other relevant provisions of the EMC Directive and the RoHS Directive.	
<b>Australia and New Zealand</b>	RCM Mark, Australia/NZ Emissions Compliant	

**TEC3000 Series Single- or Two-Stage Economizer Thermostat Controllers (Part 2 of 2)**

<b>Shipping Weight</b>	<b>Models without Occupancy Sensor</b>	0.75 lb (0.34 kg)
	<b>Models with Occupancy Sensor</b>	0.77 lb (0.35 kg)

*The performance specifications are nominal and conform to acceptable industry standards. For application at conditions beyond these specifications, consult the local Johnson Controls office. Johnson Controls shall not be liable for damages resulting from misapplication or misuse of its products.*

**European Single Point of Contact:**

JOHNSON CONTROLS  
WESTENDHOF 3  
45143 ESSEN  
GERMANY

**NA/SA Single Point of Contact:**

JOHNSON CONTROLS  
507 E MICHIGAN ST  
MILWAUKEE WI 53202  
USA

**APAC Single Point of Contact:**

JOHNSON CONTROLS  
C/O CONTROLS PRODUCT MANAGEMENT  
NO. 22 BLOCK D NEW DISTRICT  
WUXI JIANGSU PROVINCE 214142  
CHINA



**Building Technologies & Solutions**  
507 E. Michigan Street, Milwaukee, WI 53202

*Metasys® and Johnson Controls® are registered trademarks of Johnson Controls. All other marks herein are the marks of their respective owners. © 2016 Johnson Controls.*